

B50

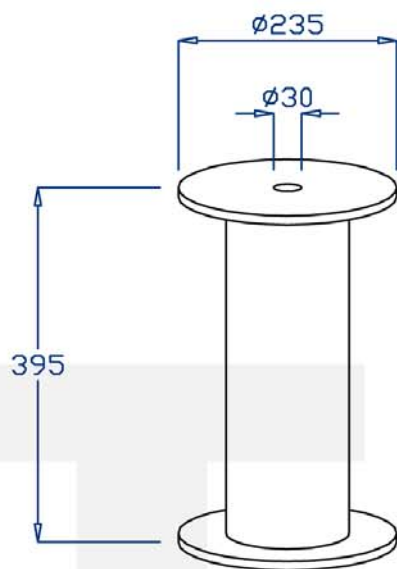

SPECIFICHE BOBINA

Kg 50

$\varnothing E$ 235 mm
 $\varnothing I$ 30 mm
H 395 mm

SPECIFICHE IMBALLO

50 x 9 Kg 450

